

# ***INSTRUCTION BOOK OWNER'S MANUAL***

**MD7A, MD7A/110S**

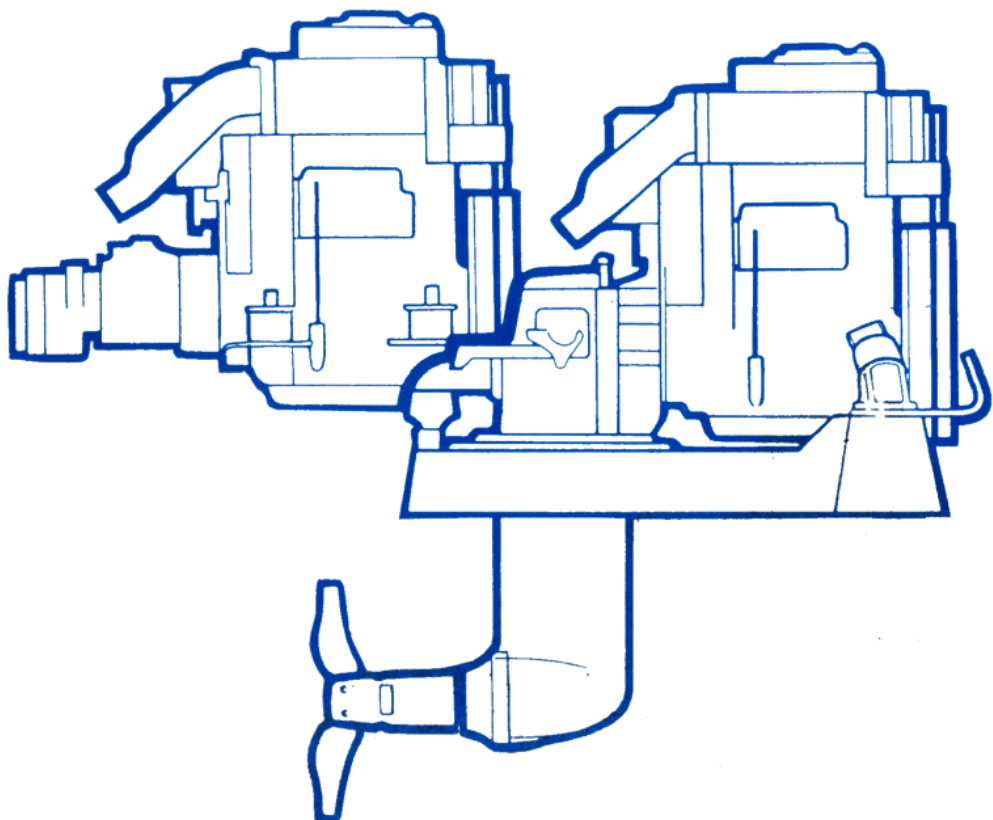

**VOLVO  
PENTA**



## **FOREWORD**

Before you start your new Volvo Penta marine engine, you are advised to read through this instruction book carefully. It contains information relevant to the proper operation and maintenance of your engine.

Volvo Penta has built up an extensive service organization with service shops and specially trained personnel at your service.

Always contact your local Volvo Penta representative for advice and when in need of service and parts.

## **WARRANTY CERTIFICATE**

A warranty certificate is supplied with each engine. It contains the warranty conditions for the engine and should be studied carefully.

Also included is a report card which is to be completed by the dealer or boat seller and forwarded to Volvo Penta.

However, if our warranty is to apply, it is an absolute condition that the measures given in the "Check and Service Scheme" are carried out and that your engine and equipment are looked after according to the instructions in this book. When in doubt, always get in touch with an authorized Volvo Penta dealer.

In all correspondence with your dealer and when ordering parts, always state the type designation and serial number of the engine and reverse gear or drive (see starboard side of engine).

Make certain that the engine's specification coincides with what is described in this instruction book.

**AB VOLVO PENTA**  
**Technical Publications Dept.**



---

Instruments and Controls	2
General Information	3 - 4
Running Instructions	5 - 6
Starting the engine	5
Running instructions	6
Shutdown procedure	6
Technical Description	8 - 11
Checks and Service Scheme	12
Checks and Service	13 - 23
Check daily before starting	13
Check every 14 days	13 - 14
Service every 50 hours of operation	15 - 16
Service every 100 hours of operation	17 - 22
Venting the fuel system	23
Service when laying-up and launching	24 - 28
Fault Tracing Scheme	29
Technical Data	30 - 31
Wiring Diagram	32
Engine Component Guide	33 - 34
Index, alphabetical order	35

---

## INSTRUMENT PANEL



1. Switch, extra lighting
2. Warning lamp, "high temperature"
3. Place for instrument (dia 52 mm, opt. equipment)
4. Warning lamp, "low oil pressure"
5. Switch, extra lighting
6. Warning lamp, "No battery charging"
7. Buzzer, "low oil pressure, high temperature"
8. Key switch

## CONTROL SYSTEM

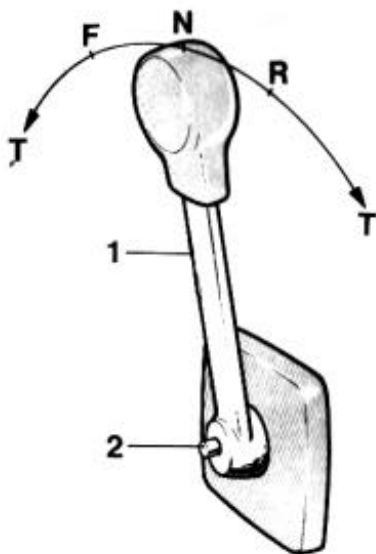

### Volvo Penta Single Control System

For side mounting

1. Control lever
2. Disengaging button  
Push in the button when the control lever is in neutral and move the lever a bit forwards. Release button. The lever is now used only for engine speed control. To use the lever for both engine speed control and gear-changing, push in the button and pull back the lever to neutral position and move it again "Forward" or "Reverse".

N = Neutral

F = Control lever in position for running "Forward"

R = Control lever in position for running "Reverse"

T = Engine speed control

## Important information on the function of your engine:

### FUEL

Use diesel fuel oil of quality "Autodiesel". Lower fuel quality can cause interruptions in operation.

### LUBRICATING OIL

Use only oil with quality CD (DS) according to the API-System. Volvo Penta oil for diesel engines can be used with advantage since it meets these quality demands. See under "Technical Data" concerning viscosity if any other oil is used.

### RUNNING-IN

A new marine engine must be run-in with due care during the first 20 hours of operation. If full output is taken out during this time, it should only be done for short periods.

**Oil change.** Change the engine oil and oil filter after the engine has been run for 20 hours. See further under "Checks and Service".

### ENGINE SPEED

Max. engine speed: MD7A 43.4 rev/sec (2600 rpm). In order to select the correct propeller, reference is made to the Volvo Penta propeller diagram. Check the engine speed with normal load in the boat. In order to obtain maximum engine performance, an engine speed as high as possible should be chosen but not, however, greater than 43.4 rev/sec (2600 rpm).

**NOTE!** When the boat has been in the water for some time, the speed and max. rev/mm can drop due to marine growth on the hull. Prevent marine growth by painting the bottom of the boat with anti-fouling paint. If the boat is equipped with Sdrive model MD7A/110S – or any other S-drive model – it is important not to use an anti-fouling paint which contains copper. See further "Service in connection with launching".

### SAFETY EQUIPMENT

Irrespective of whether the boat is being used for long cruises or short bathing trips, the boat should be equipped with the safety equipment listed below. It can, of course, be supplemented further according to personal tastes. Investigate at regular intervals to ensure that there is safety equipment on board and that it is in working order.

**LIFE-JACKETS** for all on board.

**FIRE EXTINGUISHER**, approved, at least one and installed where it is easy to get at.

**DISTRESS ROCKETS** and matches. Packed watertight.

**FIRST-AID BOX**

**TOOLS** suitable for the equipment on board.

**ON BOARD KIT** containing, e.g. impeller, etc.

**ANCHOR** with line.

**RADAR REFLECTOR**

**RADIO** for listening to, e.g., weather reports.

**COMPASS** which is deviated.

**BOAT HOOK** and paddle.

**MOORING ROPES**

**FOG-HORN** and whistle.

**FLOATING ANCHOR**

**TORCH**

### PREPARATIONS BEFORE STARTING

Make sure that:

There is no **FUEL LEAKAGE**

There is no **WATER LEAKAGE** from engine and hull

There is no **OIL LEAKAGE**

There is no **SMELL OF LP-GAS** in the deep cavities in the boat or elsewhere

The **OIL LEVEL** is correct









There is enough **FUEL** for the planned voyage

The proper **NAUTICAL CHARTS** are on board for the planned voyage

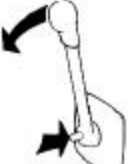
If there are persons on board who have never been in a boat before, inform them how the boat functions and where the life-jackets and fire-extinguisher are located. Also inform them of anything more you think necessary from a safety point of view. Should anything unexpected happen during the voyage, it is often too late to tell those on board how safety equipment works.





## START THE ENGINE



	<p>Switch on the <b>main switch</b>. Start the <b>engine room fan</b> (if fitted) and let it run several minutes before starting the engine.</p>
	<p>Check that cocks for fuel and water intake are open. If water in the boat, use bilge pump and drain the boat.</p>
	<p><b>Disengage the engine speed control</b> from the gear-changing as follows: Move the control lever to neutral, push in the red disengaging button, and move the lever slightly forwards. Release the button. The lever can now only operate the engine speed. Check to make sure that the stop control is pushed in.</p>
	<p><b>Turn the key switch</b> one position to the right. The warning lamps for battery charging and oil pressure should now go on and the buzzer should sound. Push in and turn the key further to the right to start the engine. Release the key when the engine starts. <b>Hand starter</b>. If the engine is started with the starting crank, the decompression handle (see pages 34-35) on the rocker arm cover should first be folded up. Return the de-compression handle for running when the engine has been cranked up in speed.</p>
	<p><b>Cold weather starting</b> CAV fuel injection pump: Starting is facilitated if the cold-start control is pulled out. The cold-start control must be pushed in after the engine has started. BOSCH fuel injection pump: The engine has a built-in automatic cold-start device.</p>
	<p><b>Check immediately after starting</b> that the warning lamps for the oil pressure and battery charging are out and that the siren is quiet. <b>If any of the lamps are on and the siren is sounding, the engine must be stopped immediately and an investigation made.</b></p>
	<p><b>Run the engine warm</b> at rapid idle. Check to make sure that the cooling water flows out with the exhaust gas es. <b>NOTE. The key switch should always be switched on as long as the engine is running to ensure battery charging.</b></p>
	<p>Reduce to idle and check that the engine is running smoothly. <b>Engage the control lever for gear-changing</b> as follows: Push in the red disengaging button and pull the lever back to neutral. Release the button. The control lever can now be used both for gear-changing and engine speed.</p>



# RUNNING INSTRUCTIONS

## RUNNING

	<p>The single lever control contains engine speed as well as gear shifting functions.</p> <p>NOTE! If the boat is equipped with a folding type of propeller, the engine speed must be reduced to idling prior to shifting to "FORWARD". Shifting at higher speed might easily damage the propeller.</p> <p>F = Forward    N = Neutral R = Reverse    T = Throttle</p>
	<p>In order to achieve good running economy, the engine should not be run at maximum engine speed for long periods of time.</p>
	<p>Check regularly during running that the warning lamp for battery charging is out. Should the cooling water temperature be too high or the oil pressure too low, the buzzer will warn you, at the same time the relevant warning lamp goes on.</p> <p><b>If this happens, the engine must be stopped immediately and the reason investigated.</b></p>

## SHUTDOWN PROCEDURE

	<p><b>Before shutdown</b> the engine should be allowed to idle for a few minutes with the control lever in neutral.</p>
	<p><b>Stop the engine</b> by pulling out the stop control when the engine is idling. Then turn back the key switch to the initial position.</p>

	<p><b>Folding propeller, S-drive.</b> When switching from engine operated running to sailing the propeller rotation is stopped by engaging reverse gear. When sailing maintain the control lever in the reverse position.</p> <p><b>Fixed propeller.</b> When sailing the control lever should be in the neutral or reverse position. During long sailing trips with the lever in the neutral position, the engine should be run for some time every tenth hour in order to ensure lubrication in the drive or reverse gear.</p>
	<p><b>Switch off the main switch.</b> NOTE! The main switch must never be switched off until the engine has stopped completely (the charging regulator can be damaged).</p> <p><b>Close</b> the fuel and cooling water cocks if the boat is not going to be used for some time.</p> <p><b>Check</b> for leakage before leaving the boat.</p>
	<p><b>In cold weather</b> and whenever there is a risk of temperatures below zero, the cooling water must be drained from the engine and the reverse gear. Close the cock on the cooling water intake, (S-drive model 110S: See page 19). Close all the drainage cocks if the boat is left without regular supervision. An incorrectly performed draining can result in a sunken boat. (See positions 15 and 16, page 34).</p>

## TECHNICAL DESCRIPTION

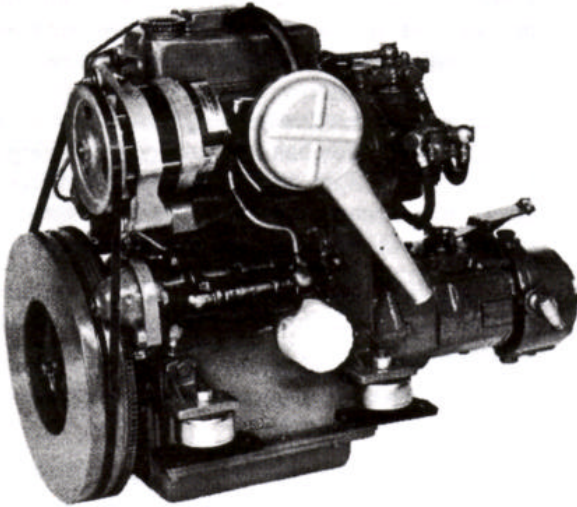

The MD7A is a 2 cylinder, 4-stroke, marine diesel engine with direct injection and sea water cooling.

### **ENGINE ASSEMBLY**

The engine block and cylinder head are made of cast iron. The engine has overhead valves.

### **LUBRICATING SYSTEM**

The lubricating system has a full-flow oil filter which cleans the oil before it reaches the lubrication points. The oil pump has a relief valve which prevents the oil pressure from becoming excessive.

### **ELECTRICAL SYSTEM**

The engine has a starter motor and an alternator with built-in rectifier. Voltage regulation is performed by a transistorized regulator, mounted on the alternator. The alternator makes it possible to charge two batteries independent of each other, if a double-diode (accessory) is fitted to the alternator.

A main fuse, which can easily be re-connected, is fixed to the engine. It protects the electrical system from damage in the event of overloading. The wiring diagrams for the engine and instrument panel are shown on page 32.

## FUEL SYSTEM

The fuel system has a feed pump with a fine filter, fuel filter with a fine filter insert, injection pump and injectors. The feed pump is of the diaphragm type and is equipped with a hand priming lever.

There is a built-in cold start device in the fuel injection pump. On the CAV fuel injection pump the cold-start device is operated manually and on the BOSCH fuel injection pump the cold-start device is operated automatically.

## COOLING SYSTEM

The engine is cooled by sea water. The cooling system has a sea water pump and a water distributor housing with a thermostat.

The sea-water pump has an impeller made of neoprene rubber, which is driven via a rubber flange from the camshaft.

The thermostat in the water distribution housing regulates the water flow so that water is always flowing in the exhaust manifold and out in the exhaust elbow regardless of whether the engine is cold or hot.

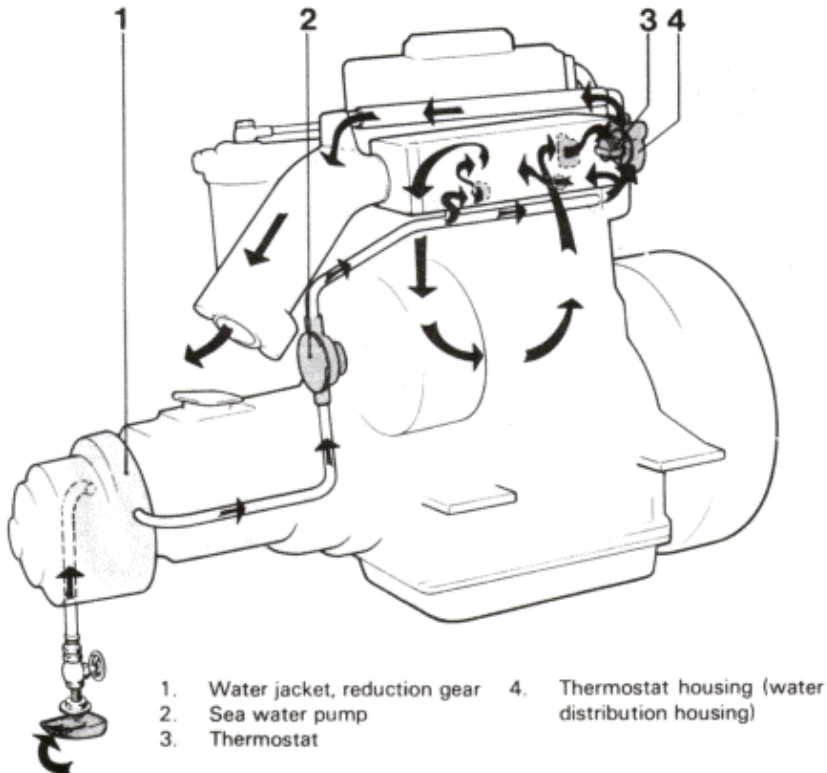

### REVERSE GEAR (MD7A/MSB)

The reduction gear is integrally built with the reverse gear. The power from the engine to the reverse gear is transmitted via a rubber flange.

For operating "Forward" and "Reverse" the Volvo patented cone clutch is used, which ensures smooth and quiet engagement. Very small forces are required to operate the reverse gear.

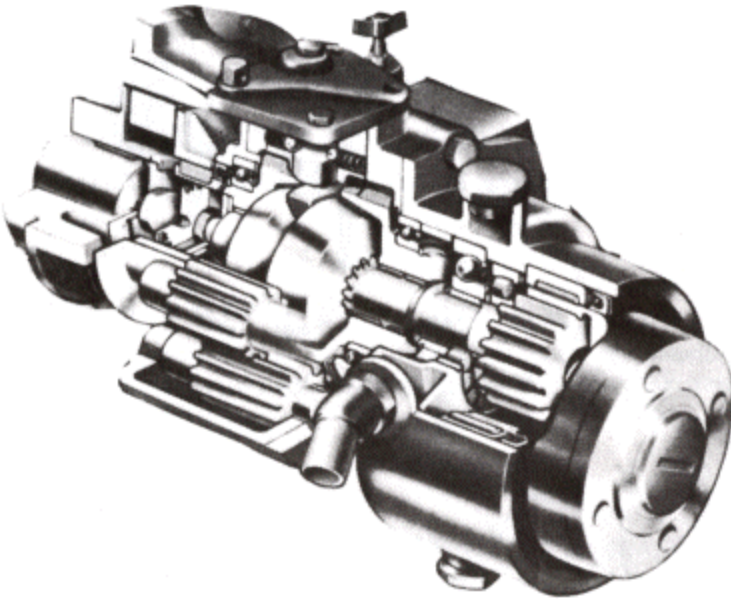

Reverse Gear type Mono Shift (MSB).

**S-DRIVE MODEL 110S (MD7A/110S)**

The power from the engine is transmitted via a rubber flange carrier to the S-Drive.

For operating "Forward" and "Reverse" the Volvo patented cone clutch is used, which ensures smooth and quiet engagement. Very small forces are required to operate the reverse gear.

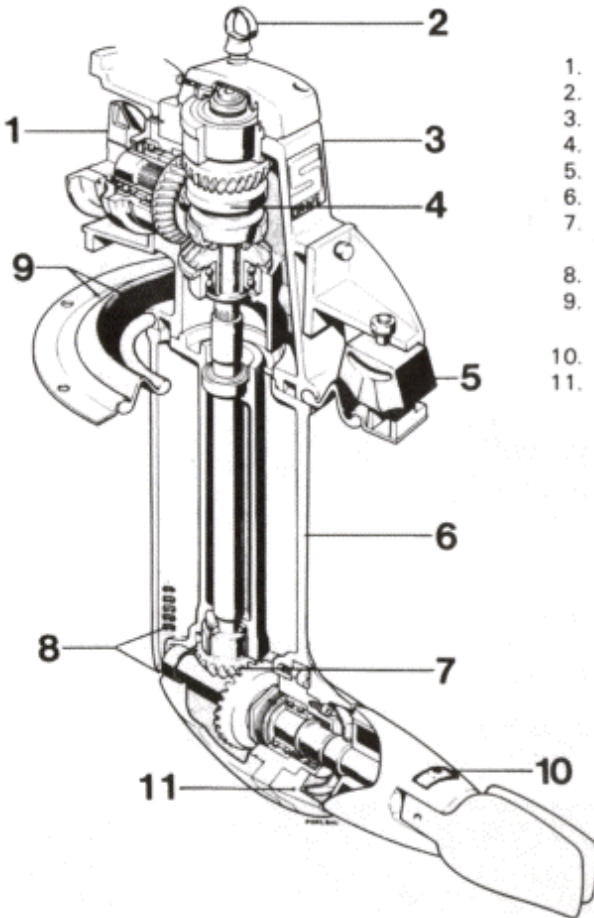

- 1. Rubber flange carrier
- 2. Oil dip stick
- 3. Upper gear housing
- 4. Cone clutch, type Silent-Shift
- 5. Rubber suspension
- 6. Lower gear housing
- 7. Propeller shaft gear with helical bevel gears
- 8. Engine cooling water intake
- 9. Flexible rubber seal between the drive and the boat bottom
- 10. Zinc plugs
- 11. Zinc ring

## CHECKS AND SERVICE SCHEME

Checks and service should be carried out regularly in accordance with the intervals given below. Let an authorized Volvo Penta Service Work Shop look after your engine.

### CHECK DAILY BEFORE STARTING that

	Page
The oil level in the engine is between the marks on the dipstick	13

### CHECK every 14 days that

The oil level in the reverse gear is between the marks on the dipstick	13
The oil level in the S-Drive is between the marks on the dipstick	14
The electrolyte level in the battery is correct	14
The belt tension is sufficient to prevent the alternator from slipping	14

### SERVICE EVERY 50 HOURS OF OPERATION:

Change the engine lubrication oil	15
Change the reverse gear lubrication oil (every 200 hours)	15
Change the lubrication oil in the S-Drive model 110S	16
Valve clearance. Checking and adjusting.	16

### SERVICE EVERY 100 HOURS OF OPERATIONS OR AT LEAST ONCE EACH SEASON:

Change the oil filter	17
Clean the air filter	17
Checking and changing the alternator v-belt	18
Check-tightening the cylinder head nuts	18
Zinc anodes, propeller (model 110S)	18
Check the cooling system	19
Electrical system. Checking and changing fuses	20, 21
Check the fuel system, filter, strainer, injector, injection pump, venting	21-23

### SERVICE WHEN LAYING-UP AND LAUNCHING THE BOAT

Inhibiting scheme	24
Service in connection with launching.	27

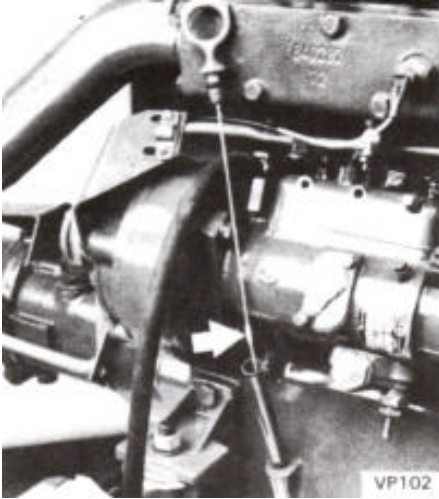

**CHECK DAILY BEFORE STARTING****OIL LEVEL IN ENGINE**

Each day before starting check that the oil level is between the marks on the dipstick. Top up with oil if necessary through the oil filler hole. NOTE. Do not top up above the MAX. mark. Concerning choice of oil, see under "Technical Data".

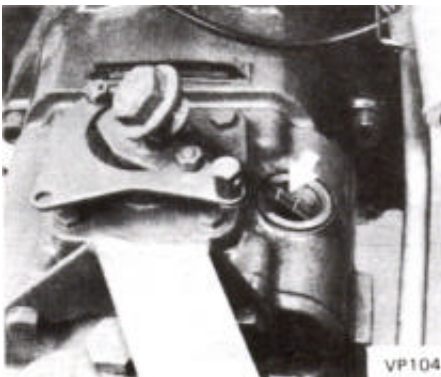
**CHECKS every 14 days****OIL LEVEL IN REVERSE GEAR**

Unscrew the dipstick, wipe it clean and insert it again without screwing it down. Pull up the dipstick and check the oil level which should be between the marks. If necessary top up with oil. Do not top up above the MAX. mark.

Screw down the dipstick again. Note that there is a sealing washer on the dipstick. Concerning choice of oil, see under "Technical Data".

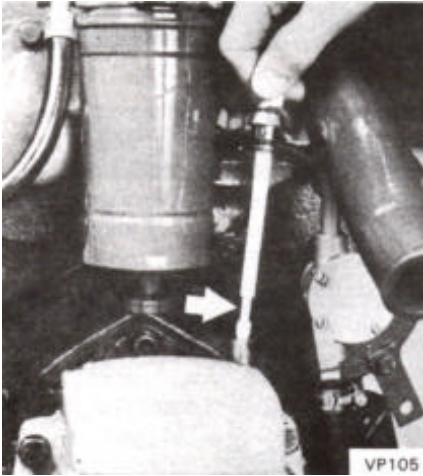

### OIL LEVEL IN THE S-DRIVE

Check every 14 days that the oil level is within the marks on the dipstick.

The oil dipstick is provided with a bayonet type of attachment. Therefore it has to be turned prior to removal and reinsertion. Note the seal underneath the oil dipstick head. When checking the oil level, the dipstick has to be turned to the locked position.

When topping-up oil, top-up through the oil dipstick hole. **NOTE!** Do not top-up above the upper mark on the dipstick. Concerning choice of oil, see under "Technical Data" Page 30.

### THE ELECTROLYTE LEVEL IN BATTERY

The level should be between 5—10mm (3/16 – 3/8") above the cell plates in the battery. If necessary top up with distilled water. **NOTE!** Exercise great care when doing this. The electrolyte is corrosive and the gas being formed is explosive.

### THE BELT TENSION

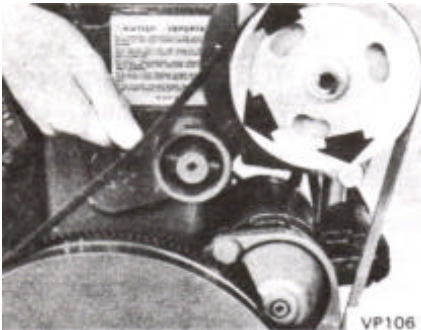

Correct belt tension is necessary for full alternator output. The belt should be tensioned in such a way that it can be depressed 5 mm (3/16") with the thumb midway between the pulleys.

The belt can be tensioned after loosening the alternator mounting bolts.

A well worn or cracked belt should be replaced. See page 18.

### SERVICE EVERY 50 HOURS OF OPERATION:

#### OIL CHANGE IN ENGINE

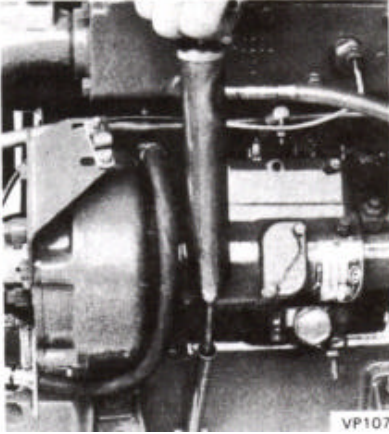

With a new or newly reconditioned engine, the oil should be changed for the first time after 20 hours of operation and after that after every 50 hours of operation.

Run the engine warm. Suck up the oil through the dipstick hole.

Fill with oil to the correct level. Concerning choice of oil, see under "Technical Data".

**NOTE!** Change also the oil filter at every second change of oil. See page 17.

#### OIL CHANGE IN REVERSE GEAR (every 200 hours of operation or at least once per season)

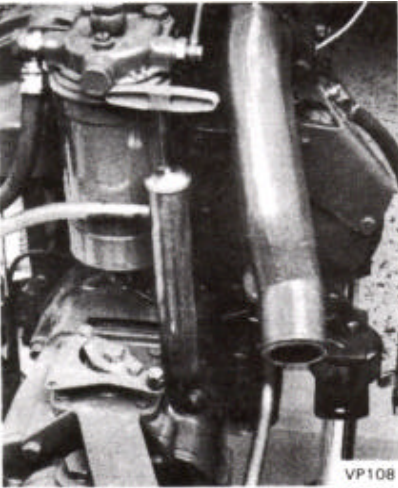

The oil can be drained from the reverse gear by removing the plugs under the reverse and reduction gears respectively (see Engine Component Guide), or by sucking up the oil through the dipstick hole with the help of an oil scavenging pump.

Fill with oil through the filler hole to the correct level. **NOTE.** Do not fill above the Max. mark on the dipstick. Concerning choice of oil, see "Technical Data".

## CHECKS AND SERVICE

### OIL CHANGE IN S-DRIVE (every 200 hours of operation or at least once per season)



Remove the oil dipstick. Remove the plug underneath the propeller gear housing and let the oil drain off. Install the plug with its O-ring. Fill oil through the dipstick hole. The oil level shall be within the dipstick marks. NOTE! Do not fill oil above the upper oil dipstick mark. Concerning the choice of oil, see "Technical Data", Page 30.

### VALVE CLEARANCE

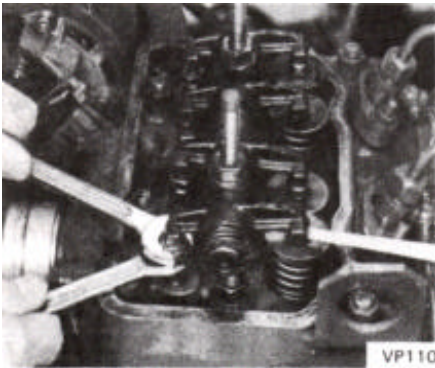

Checking and adjusting the valve clearance should be done by an authorized Volvo penta Service Workshop. See further under "Valves - Technical Data".

### SERVICE EVERY 100 HOURS OF OPERATION OR AT LEAST ONCE EACH SEASON

#### OIL FILTER

The oil filter should be replaced for the first time after 20 hours of operation during the running in period and subsequently at every other oil change. Unscrew and discard the oil filter.

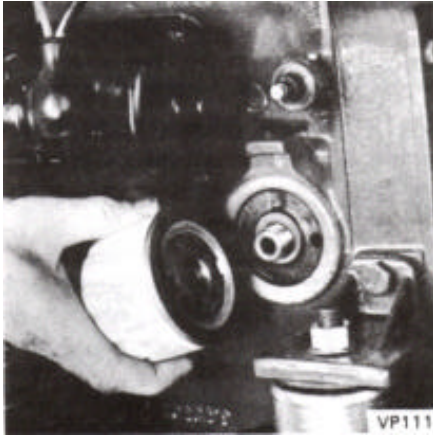

Coat the new oil filter's rubber seal with oil. Check the contact surface on the engine and screw on the filter by hand until it touches the contact surface. Turn the filter a further half turn, not more.

**NOTE.** Only use a genuine Volvo oil filter.

Start the engine, run at idling and check that the oil pressure warning lamp goes out.

Check oil level and that there are no leaks from the contact surface of the oil filter.

#### CLEANING OF AIR FILTER

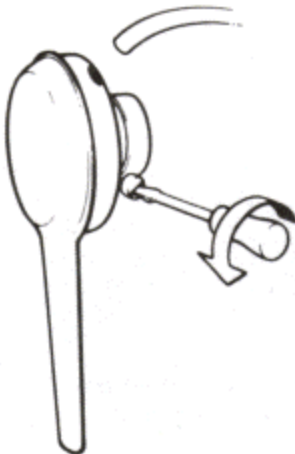

The air filter should be removed and cleaned after every 100 hours of operation or once per season.

Loosen the clamp with a screwdriver and remove the filter.

Clean the filter with diesel fuel and blow it clean with a compressed air gun. Soak it in thin engine oil.

Let the engine oil drain off and refit the filter.

### CHECKING AND REPLACING THE V-BELT

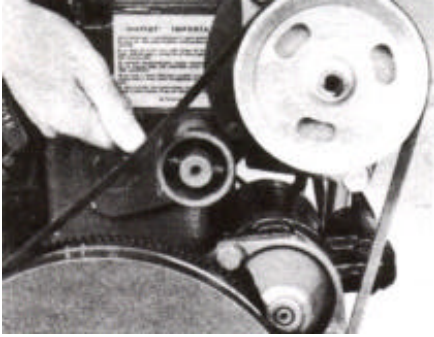

Check the belt carefully, both for wear and cracks. Any sign of such and the belt must be replaced. Loosen the alternator mounting bolts so that the belt can be removed. Clean the pulley grooves before fitting the new belt. Tension the belt so that it can only be depressed 5 mm (3/16") midway between the pulleys. After a few hours running, recheck belt tension and adjust if necessary.

### RETIGHTENING CYLINDER HEAD NUTS

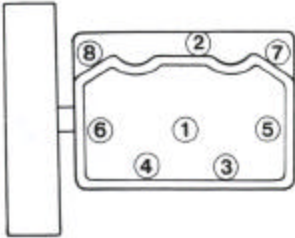

Retighten each nut **with a torque wrench** before starting a new engine or an overhauled engine for the first time, and then again after 20 hours of operation. The valve clearance should always be checked after the nuts have been retightened. Sequence for tightening nuts is shown in the figure opposite.

### ZINC-ANODE, PROPELLER (S-DRIVE 110S)

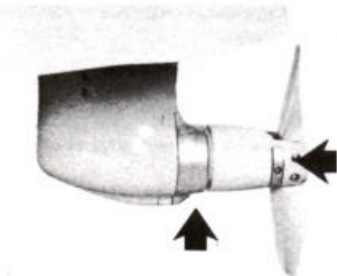

Replace the zinc-anode if it is eaten away to more than 50%. Remove the propeller and the spacer-ring with deflector and remove the Allen-head screws, holding the zinc anode. Clean the contact surface on the S-Drive and install a new zinc-anode. Be careful to obtain a good metallic contact between the S-Drive and the zinc-anode. Also replace the zinc-anodes on the S-Drive when eaten away to more than 50%. NOTE! Do not paint the zinc-anodes.

Check to make certain that the propeller-blades are folding easily, see "Inhibiting Scheme), page 26, paragr 13.



## CHECK THE COOLING SYSTEM

The cooling system is functioning normally when the temperature warning lamp is out and the buzzer is silent. Too high water temperature (the warning lamp is on and the buzzer is sounding) can be due to the following reasons: Blocked water intake, defective impeller or defective sea water pump carrier, faulty thermostat or temperature sender. **NOTE!** When working on the cooling system, be careful and avoid water coming into the boat.

### CHECKING AND CANGING THE IMPELLER

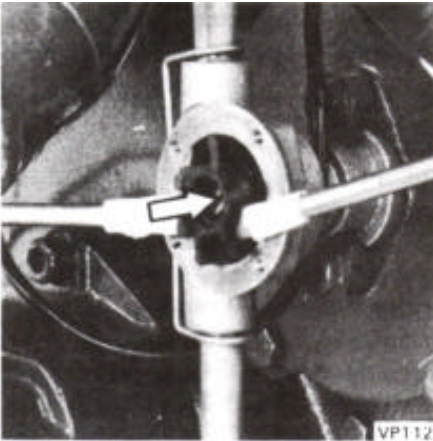

The impeller can be damaged by lack of water among other things. **Close the bottom intake valve.** Remove the sea water pump cover. If it proves necessary to replace the impeller, pull out the impeller and the shaft as far as necessary to reach the crew on the impeller hub. **NOTE!** On earlier executions: Do not pull out the shaft further than that, since the sealing rings can be damaged when the shaft is pushed back. Remove the locking screw, (on earlier executions hold back the shaft) pull off the impeller. Install a new impeller, tighten the screw and push the shaft back into position.

The carrier is defective if the impeller and shaft can be turned. A new carrier can be installed after having removed the pump. Install the water pump cover, using a new gasket. **Open the bottom intake valve.**

### COOLING SYSTEM S-DRIVE MODEL 100S

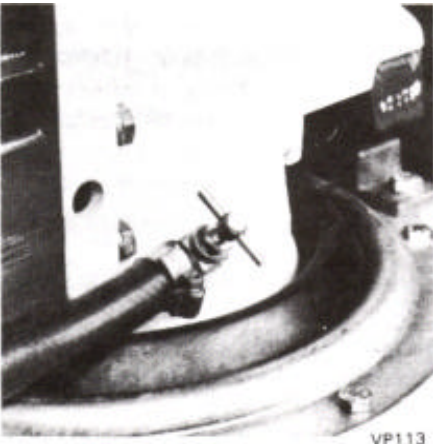

The cooling water intake for the cooling of the engine is located in the lower gear housing of the S-Drive. Check, while the boat is on land, that the gillformed water-intake and the hole in the lower edge of the S-Drive are free from marine growth. When inhibiting or when there is a risk of temperatures below zero, drain off the cooling water from the S-Drive and pump by removing the cooling water hose from the cock on the S-Drive.

**NOTE! If draining with the boat in the water, close the cock prior to start of draining.** Incorrect draining might easily end up with a sunken boat. **Do not forget** to open the cock prior to starting the engine.

## ELECTRICAL SYSTEM

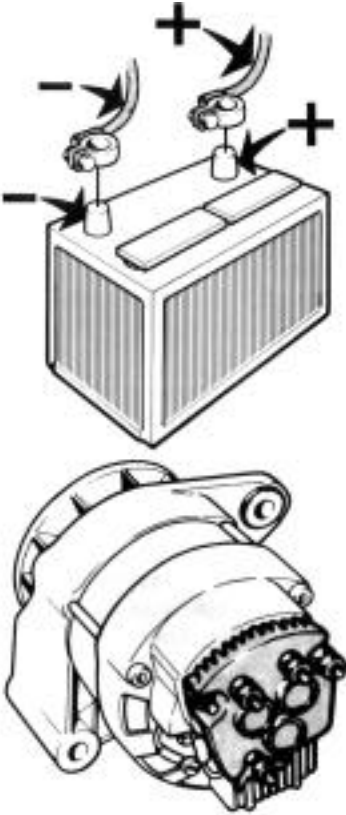

### Alternator

The engine is equipped with an alternator. To ensure that the alternator, with the built-on regulator, functions without interruptions the following important points must be observed:

1. **The main switch must never be switched off until the engine has stopped.**  
Otherwise the charging regulator will be ruined.
2. **The battery connection poles must never be mixed up.** A plus sign and a minus sign are marked on the respective poles. The minus pole is connected to the cylinder block. The cable terminals should be greased and well tightened.
3. **Switching between the charging circuits may not be carried out while the engine is running.** Fit a Volvo Penta charging distributor (accessory) on the alternator when more than one battery is connected up.
4. **Observe the following whenever the engine is started with an auxiliary battery:**  
Let the ordinary battery remain connected. Connect the auxiliary battery to the ordinary battery, plus to plus and minus to minus. When the engine has started, remove the auxiliary battery but do not break the ordinary battery's wiring circuit.
5. Do not use a rapid charging unit when the alternator is connected to the battery.
6. Before doing any work on the alternator equipment first disconnect both the battery cables.
7. In the event any electrical welding work is done on the engine or the installation components, disconnect the charging regulator cables at the alternator and insulate the cable ends.
8. Check regularly the belt tension and the cable connections.



## Changing the Fuse

A fusebox is mounted on the engine. The fuse breaks the electrical system when overloaded. Re-connect the electrical system by transferring the cable connection to the next fuse contact.

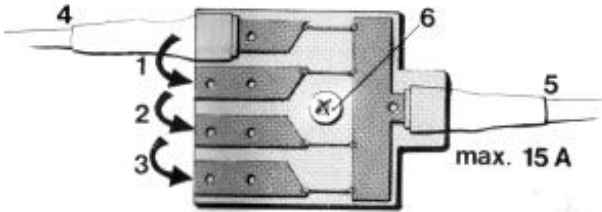

## Starter motor and alternator

All work connected with the starter motor and alternator should be done by an authorized service workshop.

Inspection and control should be carried out in connection with a general inspection of the engine.

## BATTERY

### Checking the state of the battery charge

The charging of the battery should be checked at least once each season. This is done by using a hydrometer, which shows the specific gravity of the electrolyte, this varying with the state of charge. (See "Technical Data").

## FUEL SYSTEM

Observe the greatest cleanliness when working on the fuel system. NOTE! Try to avoid spilling fuel!

### Changing the fuel filter

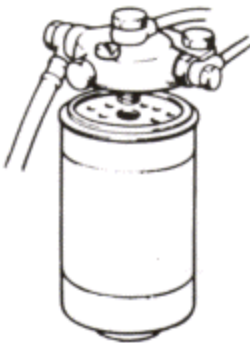

The fuel filter must be replaced least once per season. NOTE! If an extra fuel filter is installed in the boat, this filter or filter element must be replaced as well.

Remove the filter, if necessary push a screwdriver through the filter and use the screwdriver as a lever. NOTE! Be careful not to spill oil. The fine-filter is a throw-away-type of filter. Therefore throw away the old filter and install a new one. Check that the contact surface of the oil filter housing is clean and that the oil filter gasket is undamaged. Install the new filter

by hand until the gasket touches the contact surface of the housing. Then turn the filter a further  $\frac{1}{2}$  turn. Vent the fuel system (see page 23) and check for leakage.

### Extra fuel filter

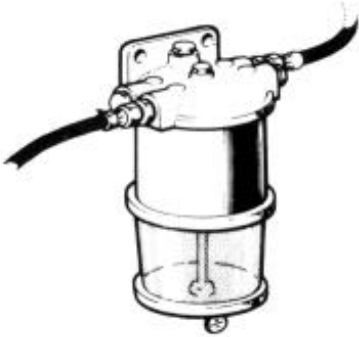

If an extra fuel filter with water separator is fitted, check the transparent bowl to see if there is any water in the fuel. If necessary, drain the filter via the cock in the bottom of the bowl. Try to avoid spilling fuel. Pump up the fuel and vent the system. The fuel filter element should be changed at least once a season.

### Fuel Strainer

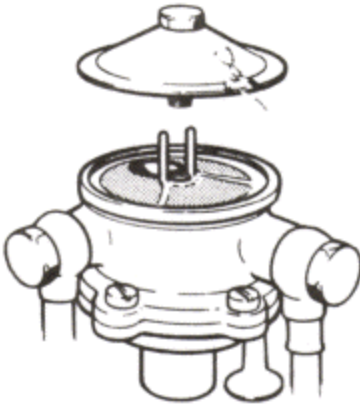

The fuel pump on the engine has a built-in strainer, which can be removed by removing the pump's cover. The strainer must be cleaned at least once per season. Always vent the fuel system. See "Venting of Fuel System" (page 23). **Check immediately after starting that there is no fuel leakage.**





### Injectors

All work on the engine injectors shall be carried out by an authorized Volvo Penta Service Workshop. Each third season the injectors should be handed over a diesel workshop for cleaning and checking the opening pressure, leakage and spray pattern.

## Venting the fuel system

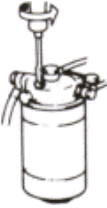
Venting of the fuel system must be carried out prior to the first start of the engine and after work has been carried out on the fuel system, when the fuel tank has been run empty or if the engine has been out of operation for some time.

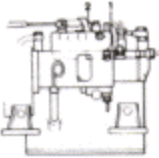
Venting is carried out as follows: (Regarding location, See Engine Component Guide).

 <p>1</p>	<p>Open venting screw on fuel filter about 4 turns. Be careful not to spill fuel. Use rags around the vent opening.</p>
 <p>2</p>	<p>Pump up the fuel by using the hand primer until fuel, free from air bubbles flows out. Close venting screw. If the pump action is poor, turn the engine so that the cam driving the pump changes position.</p>
 <p>CAV</p> <p>3</p>	<p>If the injection pump has been removed, or when first starting a new engine, the injection pump must be vented. BOSCH Fuel Injection pump: Operate the handprimer for approximately half a minute. The injection pump is then automatically vented. CAV Fuel Injection pump has two air venting screws, see picture. Vent No 1 and then No 2. Operate handprimer until fuel free from air bubbles flows out at screw No 1. Tighten screw No 1. Put throttle control lever in position full speed and turn engine using starter motor until fuel free from air bubbles flows out of screw No 2. Tighten screw No.2.</p>
 <p>4</p>	<p>Loosen the injector's delivery pipe nut, push in the stop control and put the throttle lever in full speed position. Turn the engine using the starter motor until fuel flows out of the delivery pipes. Be careful not to spill fuel! Use rags around the venting location. Tighten the delivery pipe nuts and start the engine.</p>



## SERVICE IN CONNECTION WITH LAYING-UP AND LAUNCHING THE BOAT, INHIBITING ENGINE AND REVERSE GEAR

### Idle engine for short periods of time, with the boat in the water



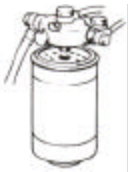

In order to prevent damage to the engine caused by corrosion, the engine should be run warm at least once every 14 days as long as the boat is in the water. If the boat is not be used for over a month, a long-term inhibiting should be carried out.

### Inhibiting for the winter lay-up





Prior to inhibiting the engine for the winter lay-up, an authorized Volvo Penta Service Workshop should test the engine and equipment. It is advisable to check the compression in order find out the condition of the engine. If the inhibiting work can be made directly after the boat is out of the water, it is advisable to run the engine warm in the water. This will facilitate the oil change.



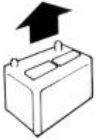

<b>INHIBITING SCHEME</b>	
<b>Carried out with the boat on land</b>	
 <p>1</p>	<p>Change the fuel filter.                      If an extra fuel filter is installed, drain water and impurities and replace the filter insert.                      Pump up fuel and vent the system. See "Venting the fuel system", page 23.                      Check out the system for leakages.</p>
 <p>2</p>	<p>Drain the cooling water from the engine and the reverse gear (paragraphs 15 and 16, page 34). Check to make sure that the water drains off, since impurities can block the cock. Then close the cock and install the plug in the reverse gear.</p>
 <p>3</p>	<p>Remove the suction line from the reverse gear (MD7A/MSB) and from the cooling water pump (MD7A/110S). Install a hose with an inner diameter 1/2" and insert the free end into a container with fresh water. Make sure to have additional water at hand to fill the container.</p>

## LAYING-UP AND LAUNCHING

 <p>4</p>	<p>Run the engine at idle for 5 – 10 minutes in order to thoroughly flush the engine with fresh water. Make sure that the exhaust does not splash vital objects. Drain all water from engine an reverse gear. Then close all draining cocks. NOTE! Do not let the propeller rotate.</p>
 <p>5</p>	<p>Remove all oil from the engine and from the reverse gear and S-Drive respectively.</p>
 <p>6</p>	<p>Change the oil filter. Fill up the engine, reverse gear and S-Drive respectively to the correct level. Use the Volvo Penta diesel engine oil with protective properties against corrosion. Now the engine is ready to run on this oil during the coming seas on.</p> <p>Always use a special inhibiting oil if the lay-up will exceed one normal winter lay-up. This inhibiting oil should be of the type Esso Rustban 623, Shell Ensis Oil or of an equivalent type. If inhibiting oil is used the oil filter must be replaced at the time of launching the boat.</p>
 <p>7</p>	<p>Prepare a rust-protection mixture consisting of fresh water and 5% Volvo Penta rust-protection-oil and emulsifying oil. NOTE! Water first and then the oil.</p> <p>Following rust-protection-oils can also be used: Esso Cutwell 40, Shell Donax C or equivalent. As an alternative to these oils, a 40 % Ethylene Glycol-mixture can also be used.</p> <p>Following for MD7A with reverse gear: An Ethylene-Glycol mixture must be used when and if engine inclination exceeds 10°. Otherwise the water, which still remains, can cause damage due to freezing.</p>
 <p>8</p>	<p>Insert the hose into the rust-protection-mixture. Start the engine and let it run in idling until the mixture is finished. NOTE! The cooling water pump will be damaged if it runs without water.</p>

## LAYING-UP AND LAUNCHING

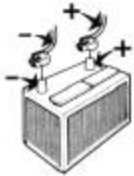
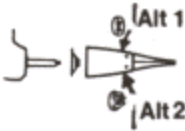
 <p>9</p>	<p>Since the rust-protection-mixture does not give protection against freezing, it has to be drained off from the engine and the reverse gear (paragraphs 15 and 16, page 34). There is no need to drain off the Ethylene Glycol-mixture. Remove the cover from the cooling water pump. Check the impeller for possible damage. NOTE! Do not pull out the impeller if it is undamaged. Install the cover using a new, genuine gasket. Install the cooling water hose between the cooling water intake and reverse gear and the water pump (MD7A/110S) respectively.</p> <p>Close all draining cocks. If a vacuum -valve is installed, it has to be disassembled and salt-sediments cleaned away.</p>
 <p>10</p>	<p>Clean the outside of the engine and reverse gear. Touch-in any bare patches on the paintwork with the original type of paint . Spray the components of the electrical system and all control components with anti-moisture spray.</p>
 <p>11</p>	<p>Remove the battery. For proper maintenance it needs to be charged to prevent it from being damaged.</p>
 <p>12</p>	<p>Check the flexible rubber seal between the S-Drive and the engine foundation for elasticity and that it is free from mechanical damage.</p> <p>The flexible rubber seal must replaced each 5th year. Check further that the rubber seal underneath on the boat and around the S-Drive is properly located.</p>
 <p>13</p>	<p>Following concerns the folding propeller:</p> <p>Remove the propeller from the S-Drive.</p> <p>Clean the propeller in fresh water, remove the screws from the suspension dowel pins holding the propeller blades and remove the dowel pins and the propeller blades. Clean all surfaces and then grease all the parts with proper grease. Use the Volvo Penta Special Grease. Especially the bearing surfaces on dowels and blades need careful greasing. Protect the hub of the propeller.</p>

<b>SERVICE IN CONNECTION WITH LAUNCHING</b>	
14	 <p>If Volvo Penta diesel engine oil has been used, you only need to check the oil level in the engine and reverse gear and S Drive. If preservative oil has been used, both oil and filter must be replaced. See under “Service after every 50 hours of operation”.</p>
15	 <p>Check the tightening of all hose clamps. Check that all drain-cocks are closed.</p>
16	 <p>Install the battery or batteries, which must be fully charged. Grease the cable terminals. Fit the battery cables. <b>IMPORTANT!</b> Do not mix the polarity. Tighten up the cable terminals well.</p>
17	 <p>Following concerns folding propellers: Assemble the folding propeller, remove excess grease and check that the blades are folding easily. Grease the propeller hub. Check that all the zinc anodes are in good shape. Install the propeller.</p>
18	 <p>Paint the bottom of the boat with an anti-fouling paint. If the boat is equipped with the S-Drive model 110S it is important to check that the anti-fouling paint does not contain copper, which will cause damage due to corrosion on the S-Drive. Further paint the S-Drive with the Volvo Penta anti-fouling paint. <b>NOTE!</b> Do not paint the zinc anodes.</p>
19	 <p>Pump up the fuel and vent the fuel system (see page 23).</p>

## LAYING-UP AND LAUNCHING



20

Launch the boat. Start the engine. See the instructions on page 5. Run the engine warm with the gear engaged. Check to make sure there is no leakage of fuel, air, water or exhaust gases.

Check that all functions for maneuvering are working properly.



21

When necessary contact an authorized Volvo Penta Workshop and have their specialist make the service on engine and reverse gear or S-Drive in accordance with recommendations in the servicing scheme.



## TRACING FAULTS WHEN HAVING INTERRUPTIONS IN OPERATION

The fault tracing scheme given below lists only the most usual of faults that cause interruptions in operation. With the help of the instructions given in this handbook, the owner can generally remedy most of the faults listed below. When in doubt, always contact the nearest Volvo Penta workshop.

Follow the maintenance scheme's recommendations – it helps provide trouble-free operation.

Engine does not start	Engine stops	Engine does not reach correct operation speed at full throttle	Engine runs unevenly or vibrates abnormally	Engine becomes abnormally hot	Reason	See
X					Main switch not switched on, flat battery, break in electric circuit or blown fuse.	Pages 5, 20, 21
X	X				Empty fuel tank, closed fuel cock, blocked fuel filter	Page 22
X	X		X		Water, air or impurities in fuel	Pages 21-23
X	X	X	X		Defective injectors	Page 22
	X		X		Idling speed incorrectly adjusted	Page 30
		X			Boat overloaded	Page 3
		X			Marine growth on hull	Page 3
			X		Damaged propeller	Page 18
				X	Blocked cooling water intake, cooling jackets, defective impeller, or thermostat	Page 19

# TECHNICAL DATA

## Technical Data

### General

Engine designation	MD7A
Number of cylinders	2
Propeller shaft output <sup>1)</sup> kW (HP) at 43,4 r/s (2600 rpm)	9,6 (13)
Max operating speed r/s (rpm)	43,3 (2600)
Cylinder diameter, mm (inches)	76,0 (2,99)
Stroke, mm (inches)	82,0 (3,23)
Displacement, $\text{dm}^3$ ( $\text{in}^3$ )	0,744 (45.4)
Compression pressure $\text{kp/cm}^3$ (psi) (starter motor speed)	20—24 (285—340)
Idling Speed r/s (rpm)	11—13 (650-780)
Direction of rotation looking at flywheel	clockwise
Max rearwards inclination, boat underway	15°
Max sideways inclination, boat underway	15°
Engine weight incl. reverse gear, kg (lbs)	175 (385)
Engine weight incl. S-Drive model 110S, kg (lbs)	192 (423)

### Valves

Valve clearance, hot engine:	
inlet, mm (in)	0,30 (0.012)
exhaust, mm (in)	0,30 (0.012)
Decompression device, max downwards movement of exhaust valve, mm (in)	0,5 (0.0197)

### Lubrication system

#### Engine

Oil capacity, $\text{dm}^3$ (imp qts = US qts)	
incl. filter	2,8 (2.5 =2.9)
excl. filter	2,5 (2.2 =2.7)
Oil quality	Diesel Lubricating Oil CD
Viscosity:	
above +10°C	SAE 20 <sup>2)</sup>
below +10°C	SAE IOW <sup>3)</sup>
Oil pressure, hot engine:	
idling speed, $\text{kp/cm}^2$ (psi) ..	0,8—1,5 (14—21)
at full speed, $\text{kp/cm}^3$ (psi) ..	3,5—4,0 (50—57)

### MSB reverse gear with reduction gear:

Ratio, with reduction gear	1,91:1
Oil capacity, $\text{dm}^3$ (imp qts _US qts)	0,60 (0,5—0,6)
Oil quality (same as for the engine) ..	Diesel Lubricating Oil CD
Viscosity	See under engine above!

1) Propeller shaft output to DIN Leusting B f&r Dauerbetrieb

2) Volvo Penta CD oil, Double grade.

3) Volvo Penta CD oil, Single grade.

**S-Drive Model 110S**

Ratio	1,66:1
Oil quantity, dm <sup>3</sup> (Imp qts — US qts)	2,3 (2,0—2,4)
Oil quality (same as for the engine)	Diesel Lubricating Oil CD
Viscosity	SAE20W/30 <sup>2)</sup>

**Cooling System**

Thermostat opens at °C/°F	60/140
fully open °C/°F	75/167

**Fuel System**

Injection pump, make	CAV (model DPA)
Feed pressure, kp/cm <sup>2</sup> — psi	0,75(11)
Opening pressure kp/cm <sup>2</sup> — psi	180-188 (2560-2675)
Pre-injection angle, crankshaft degrees BTDC	10°-12°

**Electrical system**

Battery voltage, volt	12
Battery capacity, max Ah	70
Starter motor rating, kW (Hp)	0,8(1,1)
Alternator rating, A (W)	35 (420)
Battery electrolyte spec.grav.:	
Charging to be carried out at g/cm <sup>13</sup>	1,230
Fully charged battery, g/cm <sup>13</sup>	1,275—1,285

**Torques**

Stud bolts cylinder head (M10x 1,5), Nm (kpm)	20 (2)
Cylinder head nuts (M10x 1,0), Nm (kpm)	70 (7)
Connecting rod bolts (M10x 1,5), Nm (kpm)	70 (7)
Crankshaft main bearing (M10x 1,5), Nm (kpm)	8 (0,8)
Flywheel nut (M16x2), Nm (kpm)	180 (18)

# WIRING DIAGRAM

## Cable Colour Code

Marking	Colour	mm <sup>2</sup>	A.W.G.
A	White	6	9
B	Black	1.5	15
B'	Black	0.6	19
B''	Black	0.75	18
C	Red	6	9
C'	Red	35	1
C''	Red	0.6	19
F	Yellow	1.5	15
G	Brown	1.5	15
H'	Blue	35	1
I	Green/Red	1.5	15
I'	Green/Red	0.75	18
J	Green	1.5	15
J'	Green	0.6	19
J''	Green	0.75	18
K	Blue/Yellow	0.75	18
L	White/Red	0.75	18
M	Blue/Red	0.75	18

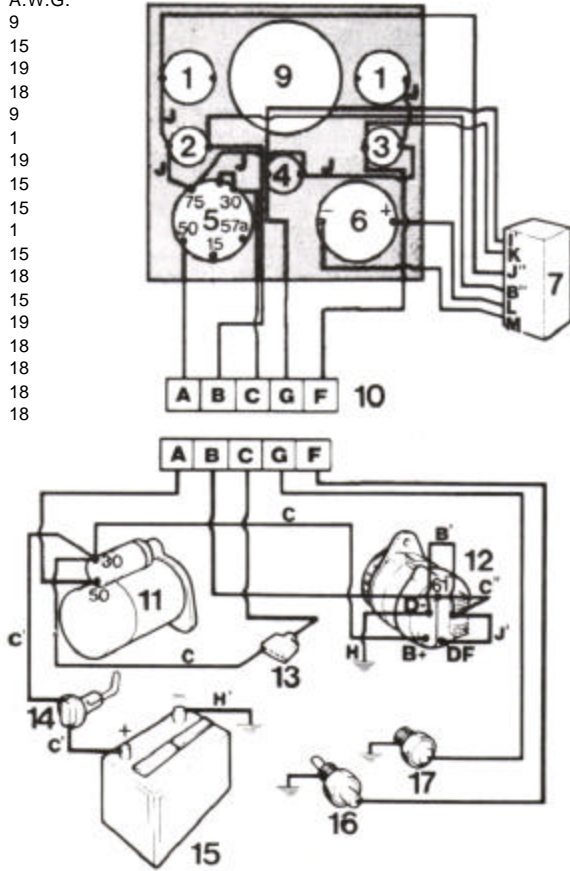

## List of Components

- |    |                                   |     |  |
|----|-----------------------------------|-----|--|
| 1. | Switch, extra lighting            | 9.  | Place for instruments, opt. equipment) |
| 2. | Warning lamp, no battery charging | 10. | Plug in connector, wire harness        |
| 3. | Warning lamp, high temperature    | 11. | Starter motor                          |
| 4. | Warning lamp, low oil pressure    | 12. | Alternator                             |
| 5. | Key switch                        | 13. | Fuse box                               |
| 6. | Buzzer                            | 14. | Main switch                            |
| 7. | Alarm-unit                        | 15. | Battery                                |
| 8. | N/A                               | 16. | Sender, temperature                    |
|    |                                   | 17. | Sender, oil pressure                   |

## MD7A with reverse gear model MSB

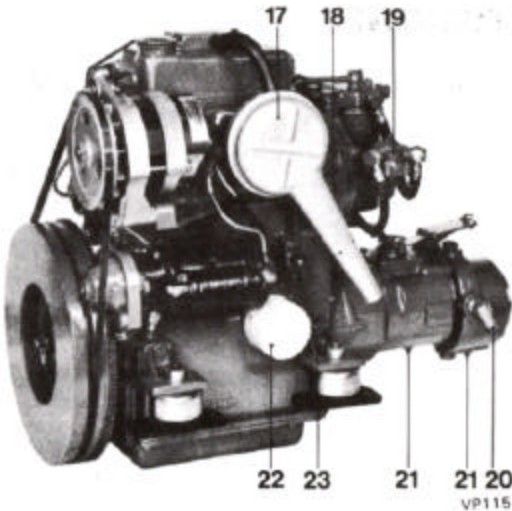
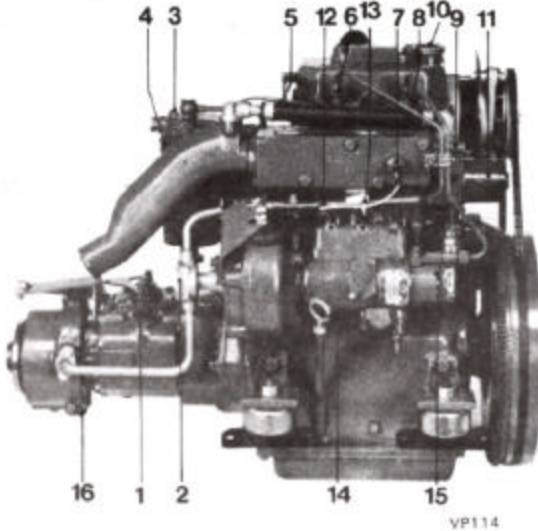

1. Oil dipstick and oil filler hole and oil scavenging reverse gear
2. Cover, cooling water pump
3. Venting screw, fine-filter
4. Fine-filter
5. Decompression lever
6. Fuel pressure line nut
7. Sender, temp gauge
8. Injector
9. Thermostat housing
10. Oil filler hole, engine
11. Hand starter
12. Stop device
13. Speed lever
14. Oil dipstick, oil scavenging engine
15. Cooling water drainage, engine
16. Cooling water drainage, reverse gear
17. Air filter and air intake silencer
18. Sender, tachometer
19. Fuel pump (with hand priming device)
20. Cooling water intake, reduction gear

# ENGINE COMPONENT GUIDES

## MD7A / 110S

21. Oil drainage, reverse and reduction gear
22. Oil filter
23. Sender, low oil pressure
24. Control cable bracket
25. Shift lever
26. Water cooled exhaust elbow
27. Sea water pump
28. Fuel injection pump
29. Oil drainage, S-Drive
30. Zinc anode
31. Alternator
32. Closed crankcase ventilation
33. Oil dipstick and oil filler hole, S-Drive
34. Closing cock for incoming cooling water
35. Flexible engine mounting
36. Flexible rubber seal between S-Drive and engine foundation
37. Cooling water intake, S-Drive
38. Engine foundation
39. Starter motor

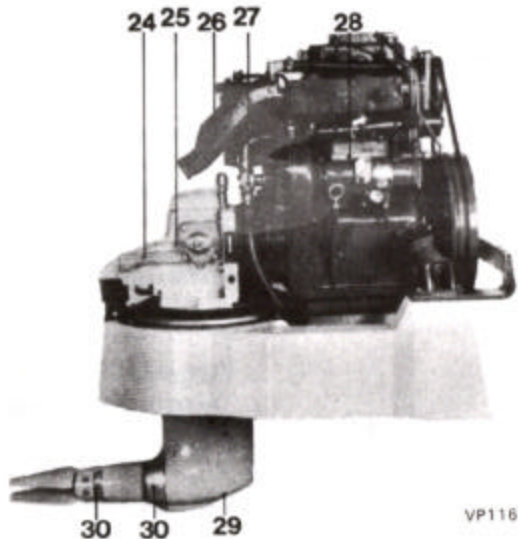
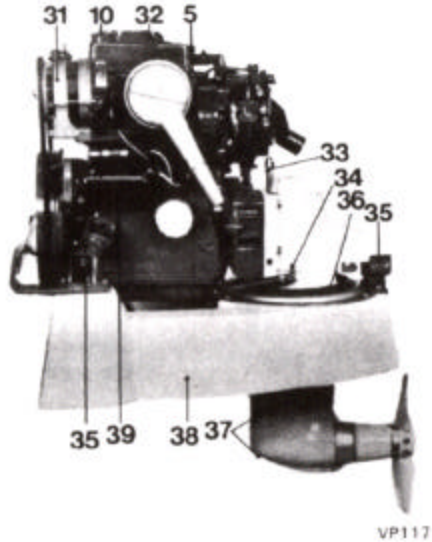

## INDEX, ALPHABETICAL ORDER

<b>Alternator</b>	20, 21	<b>Launching</b>	27
<b>Battery</b>	14, 20	Lubricating oil	3
Belt tension	14, 18	Lubricating system	8
<b>Charging regulator</b>	7, 20	<b>Main Switch</b>	5, 20
Checks & Service		<b>Oil changing</b>	15, 16
Scheme	12	Oil dipstick, rev gear	13
Controls	2	engine	13
Cooling system	9, 19	S-Drive	14
Cylinder head nuts	18	Oil filter	17
<b>De-inhibiting</b>	27	Oil level checking	13
Drain cocks	33, 34	<b>Preparations before starting</b>	4
<b>Electrical system</b>	8, 20, 32	<b>Reverse gear</b>	10
Engine body	8	Running	6
Engine component	33, 34	<b>Safety equipment</b>	4
guides		S-Drive Model 110S	11
Engine speed	3	Sea-water pump	19
<b>Fault tracing scheme</b>	29	Spare battery	20
Fine-filter	21, 22, 34	Starter motor	21
Fuel	3	Starting	5
Fuel filters	21, 22	<b>Technical data</b>	30, 31
Fuel pump	22	Thermostat housing	33, 34
Fuse box	21	<b>Valve clearance</b>	16
<b>Hand priming pump</b>	23, 33	Venting (fuel system)	23
Hand starter	5	<b>Wiring diagram</b>	32
<b>Impeller</b>	19		
Inhibiting	24-28		
Injectors	22		
Instruments	2		





# IMPORTANT INFORMATION

## Warning!

Stop the engine before opening the hatch to the engine compartment. An engine which is in operation has rotating and moving parts which is dangerous to touch. Bear in mind the risk of a fire. All engine fuel is potentially inflammable. Let an expert correct any faults in the fuel system and always use genuine Volvo Penta spare parts.

## Frost Risk

The cooling system is filled with liquid and should be drained when there is risk of frost. Note that in certain cases, a suction action may occur when the seawater system is being drained. Close all drainage points when the boat is not under constant supervision. Any incorrectly performed drainage can cause the boat to become filled with water and sink. Also bear in mind that the fresh water tank and the toilet can be damaged by frost.

## To Be Checked

The steering gear and controls must function perfectly and their operation should be checked at regular intervals. Never take any chances if you suspect that something is wrong. Take immediate action to remedy faults.

All rubber ages, so check all rubber parts at regular intervals. Parts which are of special importance are the fuel hoses and those rubber parts which have to do with the boat's flotation ability. If the hoses feel dry and hard or display any tendencies to crack, they should be replaced immediately.

## Safety Onboard

Check safety materials onboard. Run through your mind what can happen and let yourself and your crew practice drills to cope with events that you know can happen. You will benefit by being prepared if anything does happen. If you take good care of your boat and its engine, then the risk of anything happening is a small one. Read the instruction book — before it happens.



**AB VOLVO PENTA**  
BOX 392 S-401 26 GÖTEBORG 1 SWEDEN